

Universal Retrofit

Das Leuchtenmodul für fast alle Tragschienen

Universal Retrofit

Ein Leuchtenmodul passen für viele Tragschienen

Egal ob vorverkabelte oder leere Tragschiene. Mit dem Universal Retrofit Leuchtenmodul kann jedes Leuchtenmodul ersetzt werden.

Das Universal Retrofit Leuchtenmodul kann als 5-polige oder 7-polige Lichtbandleuchte konfiguriert werden.









3-Phasen EVG

Innovatives EVG Design macht es möglich



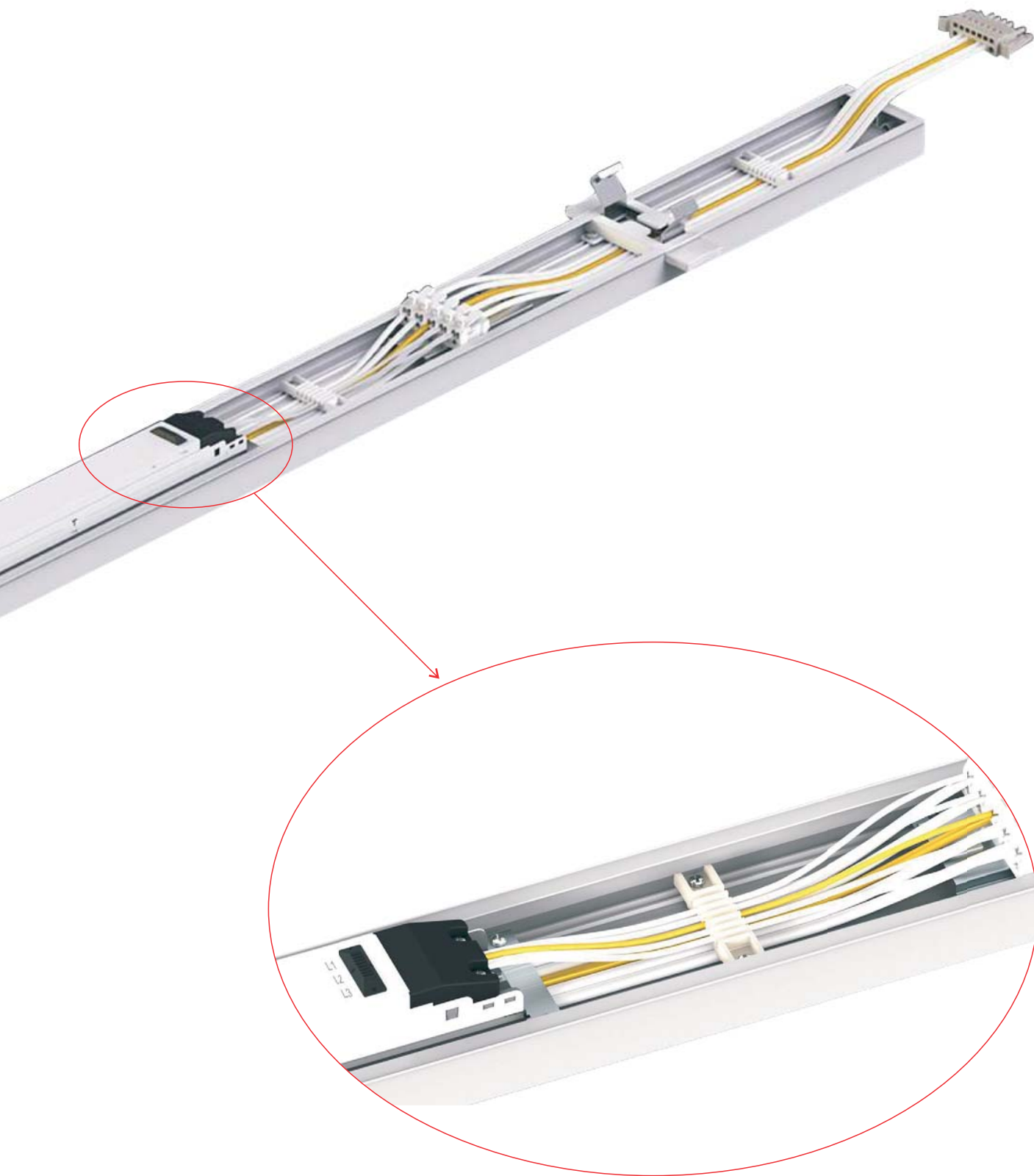

Auswahl der Phasen direkt am EVG mittels Schalter

Plug and Play

Durch den Einsatz der Clips ist die Montage kinderleicht und sehr schnell durchzuführen.



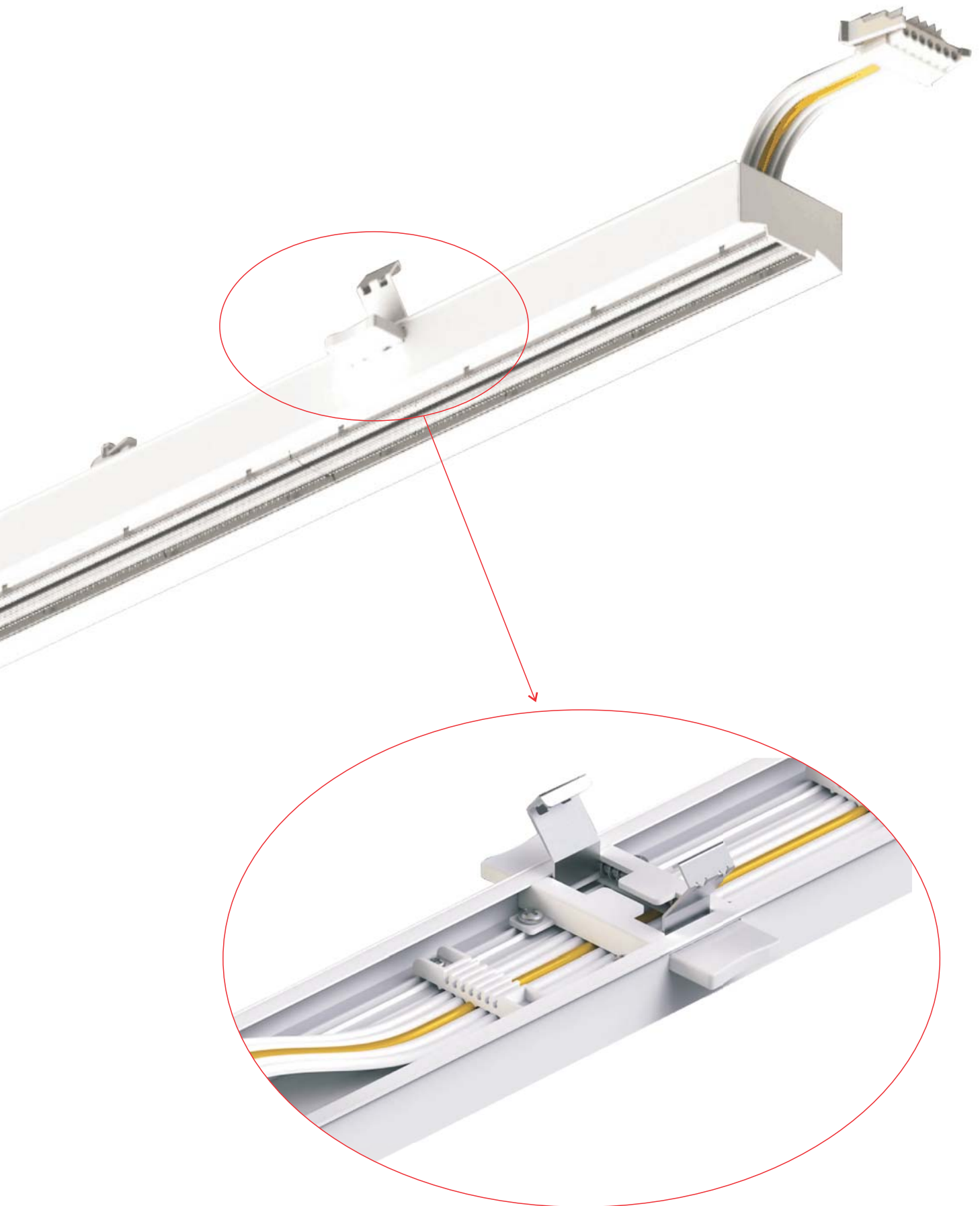

Linsenoptiken und opaler Diffusor

Fünf verschiedene Abstrahlwinkel mit Linsenoptiken und breit strahlend mittels opalen Diffusor
Mit den unterschiedlichen Abstrahlwinkel der Linsenoptiken und mit dem opalen Diffusor ist die Universal Retrofit für alle lichttechnischen Anforderungen einsetzbar.

Linsenoptiken

30x110°

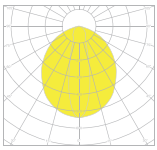

60x110°

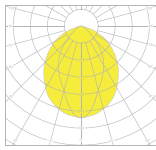

90x110°

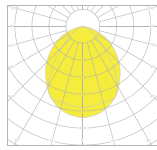

Asymmetric
L or R

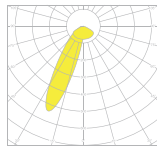

Double
Asymmetric

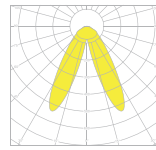



Opaler Diffusor

120°

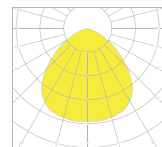

Leistung einstellbar von 25W bis 75W

Die Leistung ist mittels DIP Schalter am EVG eistellbar.

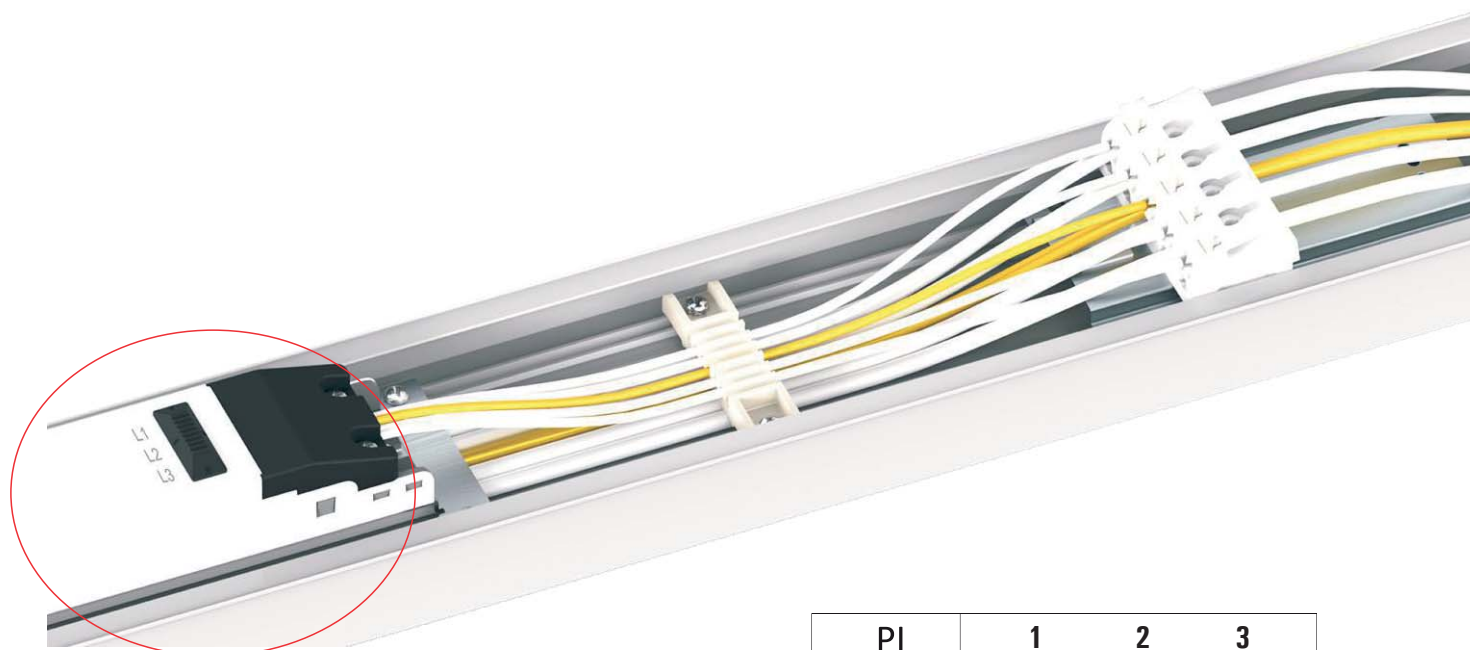

PI	1	2	3
75W	—	—	—
65W	ON	—	—
55W	—	ON	—
45W	ON	ON	—
40W	—	—	ON
35W	ON	—	ON
30W	—	ON	ON
25W	ON	ON	ON



Technische Daten

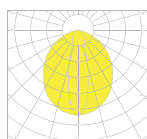

Artikel Nr.	Leistung	Abstrahlwinkel	LM/W	L (mm)	B	H
TR-U-75-840-30-(X)	25-75 W	30x110°	150lm/w	1437	66.5	24.5

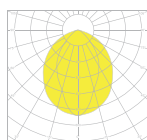

Artikel Nr.	Leistung	Abstrahlwinkel	LM/W	L (mm)	B	H
TR-U-75-840-60-(X)	25-75 W	60x110°	150lm/w	1437	66.5	24.5

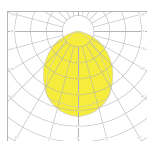

Artikel Nr.	Leistung	Abstrahlwinkel	LM/W	L (mm)	B	H
TR-U-75-840-90-(X)	25-75 W	90x110°	150lm/w	1437	66.5	24.5

Standardausführung 5 polig

Steuerung:

(X) = F für Ein/Aus

(X) = D für DALI

(X) = A für 1-10V

Lichtfarben:

850 = 5000K

865 = 6500K

Farbe:

Weiss RAL9003

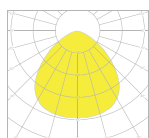
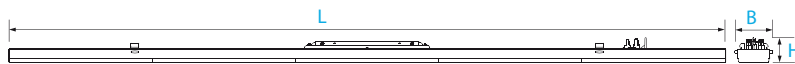

Artikel Nr.	Leistung	Abstrahlwinkel	LM/W	L (mm)	B	H
TR-U-75-840-120-(X)	25-75W	120°	150lm/w	1437	66.5	24.5

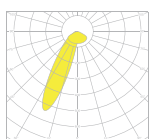

Artikel Nr.	Leistung	Abstrahlwinkel	LM/W	L (mm)	B	H
TR-U-75-840-SA25-(X)	25-75W	SA25°	150lm/w	1437	66.5	24.5

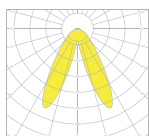

Artikel Nr.	Leistung	Abstrahlwinkel	LM/W	L (mm)	B	H
TR-U-75-840-DA25-(X)	25-75W	DA25°	150lm/w	1437	66.5	24.5

Passend für folgende Tragschienen

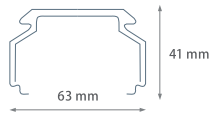
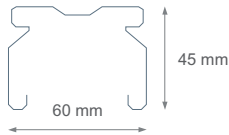
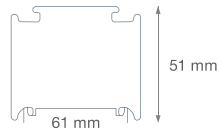
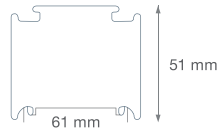
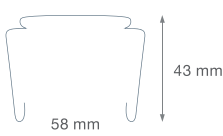
No.	Trunk brands	Model	Size
1	TRILUX	E-Line	
2	FLUOLITE	TRX	
3	LUDWIG	TR50W	
4	ZUMTOBEL	Zx1	
5	ZUMTOBEL	Zx2	
6	SITECO	DUS	
7	SITECO	Modario	
8	RIDI	VLG	
9	RIDI	VLT	

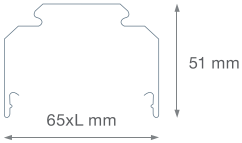
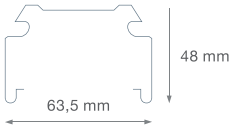
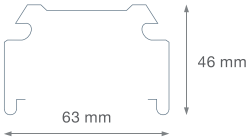
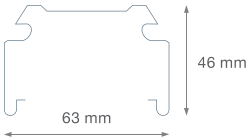
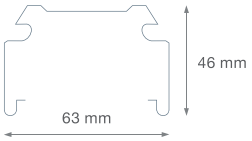
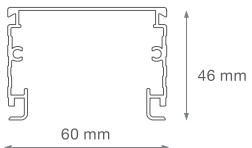
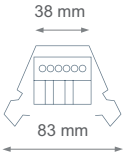
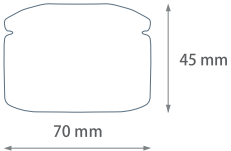
No.	Trunk brands	Model	Size
10	RIDI	SLG	
11	PHILIPS	TTX	
12	REGIOLUX	SDT	
13	REGIOLUX	SPT	
14	REGIOLUX	SMT	
15	VEKO	PRN	
16	PHILIPS	Maxos	
17	LITELICHT	Q-Rail Q-TS	

Zubehör

Absturzsicherung

2 Stück je Leuchtenmodul
Art. Nr.: TR-SC-01

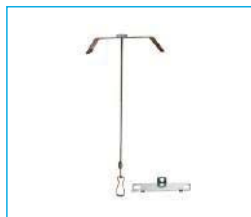

Einspeisung

230V Einspeisesteckverbindung mit Schnellverschluss
Art. Nr.: TR-AC-5
Art. Nr.: TR-AC-7



Blindabdeckung

Material: Aluminium
Länge: 1437mm
Farbe: RAL9003



1.5m Verbindungskabel

VPE: 1 Stück
Art. Nr.: TR-K-1,5-5
Art. Nr.: TR-K-1,5-7



3m Verbindungskabel

VPE: 1 Stück
Art. Nr.: TR-K-3-5
Art. Nr.: TR-K-3-7





Kontaktinformationen

smart mit led gmbh
Gorskistrasse 13, 1230 Wien
Tel. +43 (0)1 979 0995-83
Fax. +43 (0)1 979 0995-13
office@smart-mit-led.com
www.smart-mit-led.com