

? Troubleshooting

Problem	Possible Cause	Solutions
LEDs stop working	The power line is improperly connected.	Reconnect the power cable.
	The power plug is loose.	Firmly plug the power in.
	The LED driver malfunctions.	Replace with new driver.
	The LED chip is damaged.	Replace with new LEDs.
LEDs flash on and off	The output of the driver is abnormal.	Replace with new driver.
	The LED chip breaks down.	Replace with new LED chip.

☰ Warranty

5 years warranty for original purchaser of LED product that is identified on seller's invoice reflecting its original purchase (the "Product").

1. In order to make a warranty claim, you must notify seller in writing within sixty(60) days after your discovery of the defect, provide proof of purchase such as the invoice and comply with seller's other warranty requirements. Upon receiving that notice, to ascertain why fixtures stop working, evidences would be needed for seller's QC Team to analyze. Seller may require you to promptly return the Product to Seller when necessary, freight prepaid.

2. The determination of whether the Product is defective shall be made by Seller in its sole discretion with consideration given to the over all performance of the Product.

3. If seller determines the Product is defective, Seller will elect, in its sole discretion, repair the Product or replace the Product. Seller reserves the right to utilize new, reconditioned, refurbished, repaired or remanufactured products or parts in the warranty repair or replacement process. Such products and parts will be comparable in function and performance to an original product or part, as determined by Seller in its sole discretion, and warranted for the remainder of the original warranty period. However, cost of labor and equipment to remove the defective product and install a repaired or a replacement Product at the end-user facility are excluded. Supplier's aggregate liability with respect to a defective product shall in any event be limited to the money paid to buyer for that defective product.

The following circumstances will not be warranted:

1. Damage caused by force majeure such as war, riots, sabotage, cyclones, earthquakes, tidal waves, flooding, lightning strikes, explosions, fire, flood, etc.
2. Damage caused by user's improper delivery, defects caused by wrong operation, wrong treatment and destruction of machinery.
3. Dismantling or modification or improper maintenance or repairing of the products without the supplier's authorization.
4. Damage caused by buyer or installer using bad quality cable or other mismatching electronic parts.
5. This warranty is invalid if the product is not used for the purpose for which is originally designed. Any disputes occurred shall be applied to the laws and regulations of P.R.C.

The seller has the sole right to interpret and amend the above articles.

LED Fluter Solax

Montageanleitung



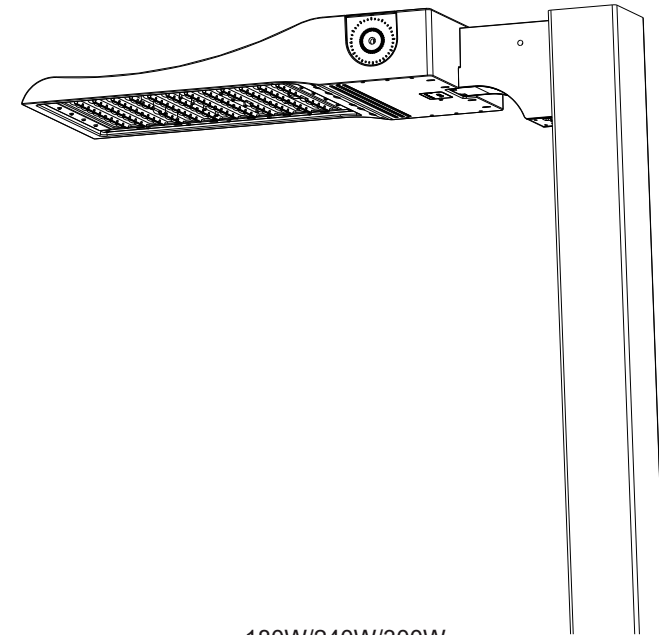

180W/240W/300W

Reminder

We appreciate your purchase!
Please read the instruction manual before installation and keep it for future reference.

Warning

- To avoid damage, falling, electric shock or fire, please do not modify the lamp or replace accessories without confirming with the supplier first.
- Please authorize only qualified personnel to install the lamp and ensure they follow the instruction manual. Any improper installation might cause falling, electric shock, fire, or other injury, damage or hazard.
- Please disconnect power before installation or any maintenance of the lamp.
- Please disconnect power if it begins to smoke or emit odors, since fire or electric shock may occur. Ask qualified person to inspect and maintain the luminaire.
- Please do not dismantle the lamp without the supplier's authorization.
- Please do not touch the power supply when the lamp is operating.
- If the external flexible cable or cord of the luminaire is damaged, it should only be replaced by the supplier, a service agent or qualified person.
- Terminal block not included. The electrical fitting must be installed by a licensed electrician.
- The light source contained in this luminaire shall only be replaced by the manufacturer or his service agent or a similar qualified person.
- Only to be installed outside arms reach.
- For use in environments where an accumulation of non-conductive dust on the luminaire may be expected.
- Mounting heights of light s not higher than 15m.



Caution risk of electric shock

Application

With aluminum heat sink, high-brightness SMD chip, high-efficiency constant current and voltage power driver, the LED Street Light is designed for highway, main roads, secondary roads, small roads, etc.

Technical Parameters

Product Specifications		180W	240W	300W
Input Voltage		AC100-240V / AC100-277V / AC200-240V / AC220-240V / AC277-480V		
Power Frequency		50 / 60Hz		
Normal	Outlook Dimensions	571x322x94mm (22.48"x12.68"x3.7")		
	Luminaire Net Weight	7.8±0.3kg (17.2±0.66Lbs)	8.4±0.3kg (18.52±0.66Lbs)	
Photocell	Outlook Dimensions	571x322x160mm (22.48"x12.68"x6.3")		
	Luminaire Net Weight	8±0.3kg (17.64±0.66Lbs)	8.6±0.3kg (18.96±0.66Lbs)	
Working Temperature		-30°C to +50°C (-22°F to +122°F)		
Storing Temperature		-40°C to +70°C (-40°F to +158°F)		

Bracket 4

1.

2.

3.

NON-DIMMABLE

DIMMABLE

Wiring Diagram

Bracket 3

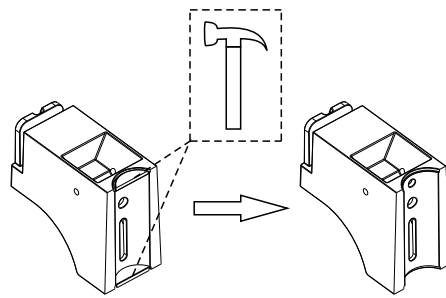
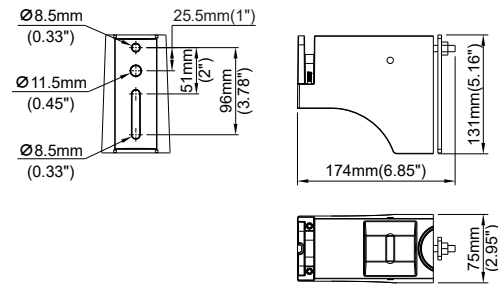

Square pole

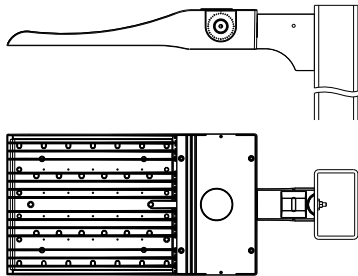

Round pole (pole diameter >60mm)

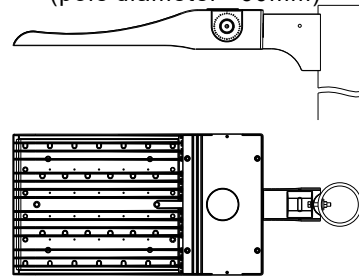

1. ✂

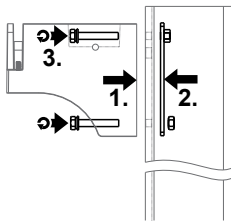

2. ✂

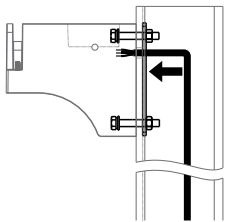

3. ✂

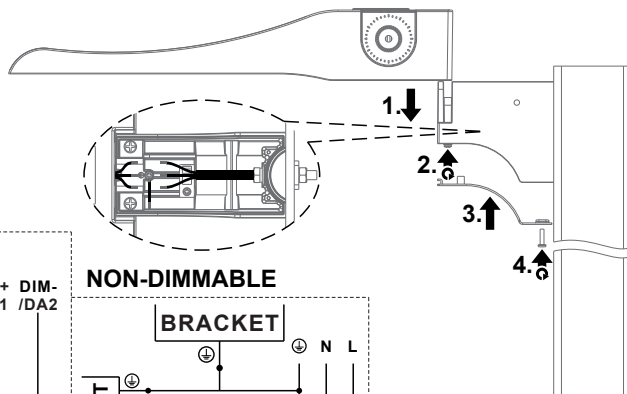

DIMMABLE

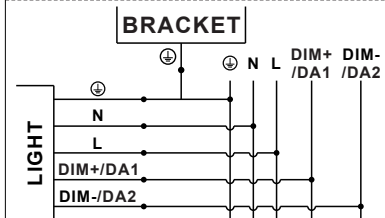

NON-DIMMABLE

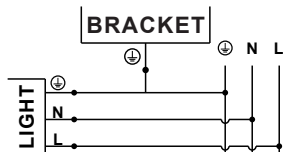

Installation Instructions

Physical Dimensions(mm/inch)

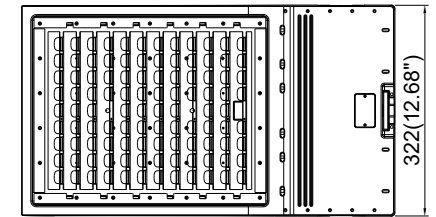
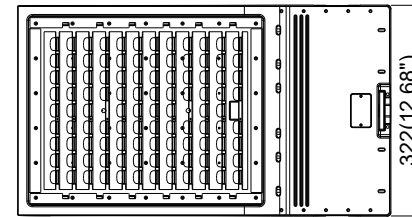

Photocell

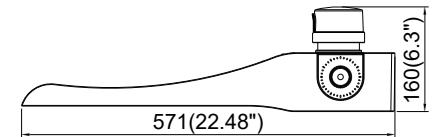
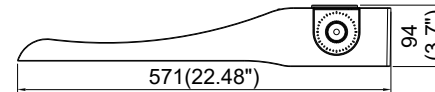

Twist Lock Photocell

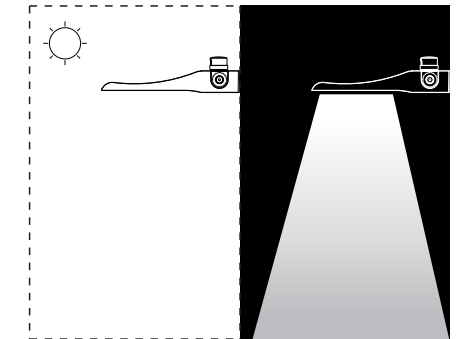
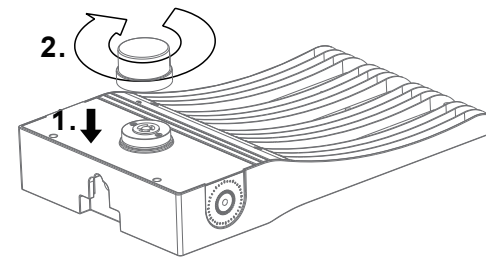

Rated Voltage	120-277VAC	Turn-Off Level / Time-Delay	60Lx / 2~15s
Applicable Voltage Range	105-305VAC	Ambient Temp.	-40 ~+ 70 (-40°F~+158°F)
Rated Frequency	50/60Hz	Related Humidity	99%
Rated Loading	1000W Tungsten, 1800VA Ballast	Service Life	5000 times
Power Consumption	1.0VA	Overall Size	Ø84 x 66mm (Ø3.31" x 2.6")
Turn-On Level / Time-Delay	10Lx / 15~120s	Weight Approx.	0.088kg (0.194Lbs)

Bracket 1

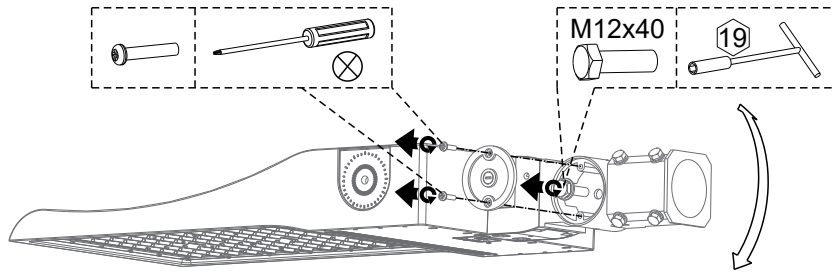
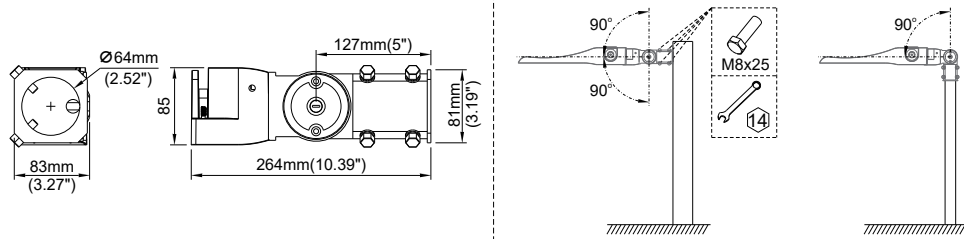

1. ✂

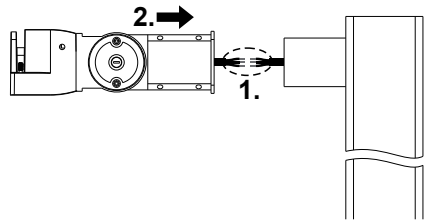

2. ✂

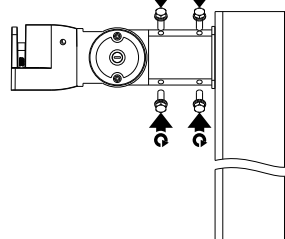

3. ✂

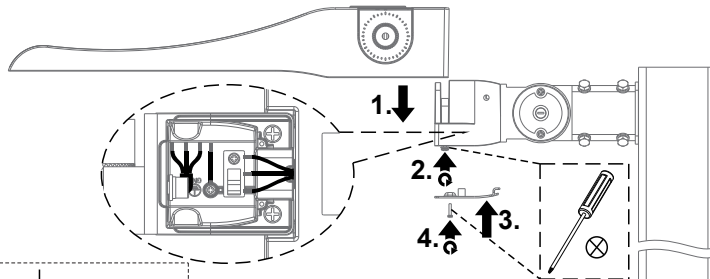

DIMMABLE

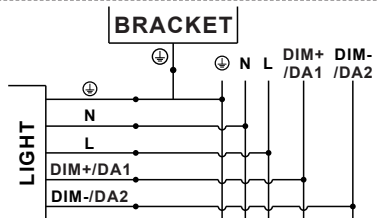

NON-DIMMABLE

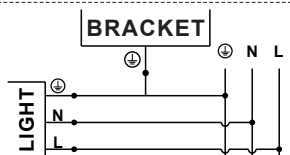

Bracket 2

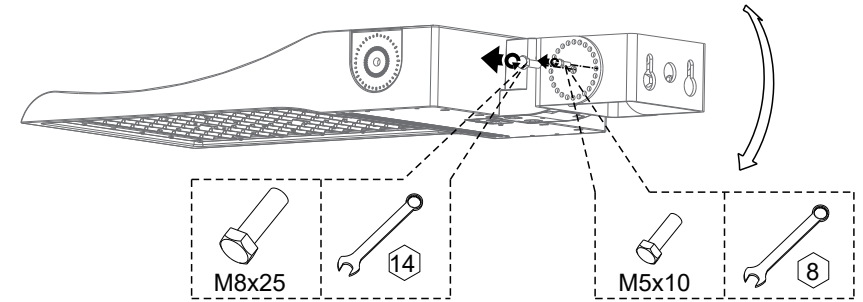
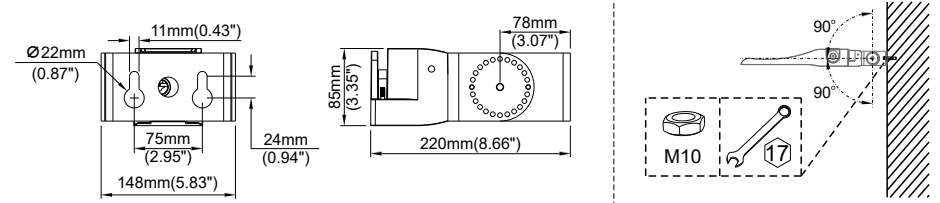

1. ✂

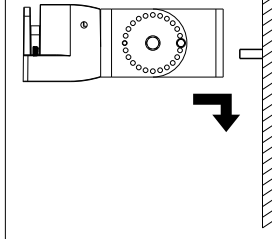

2. ✂

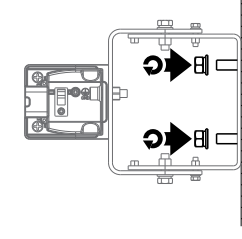

3. ✂

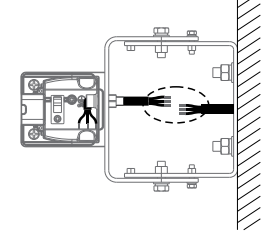

4. ✂

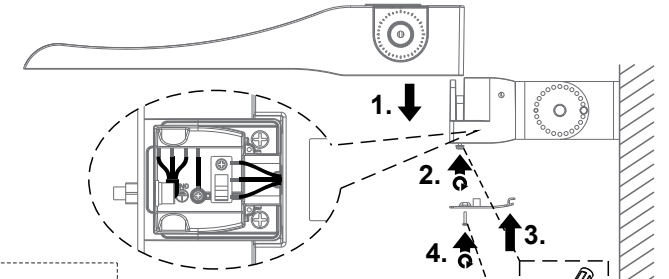

DIMMABLE

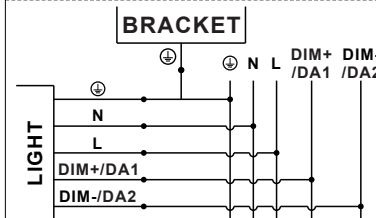

NON-DIMMABLE

